

Datamet



Datamet Wall Mount Enclosures

Modern aluminium enclosures designed for indoor applications. Provide total access to the electronics during installation on the wall. Stylish design with die-cast front bezel, top cover and 'L' shape rear panel. Front panels and internal mounting plates ordered separately.

Datamet Wandgehäuse

Moderne Aluminium-Gehäuse für Innenanwendungen. Elektronik während der Wandinstallation frei zugänglich. Elegantes Design mit Zink-Druckguss Frontrahmen, Haube und Rückplatte in L-Form. Front- und Montageplatten als Zubehör.

Boîtiers Muraux Datamet

Des boîtiers en aluminium modernes pour des applications dans l'intérieur. Accès à l'électronique sans barrière pendant l'installation au mur. Design élégant avec bandeaux frontales, partie supérieure et panneau arrière en forme L moulés sous pression. Panneaux frontales et plaques internes à commander séparément.

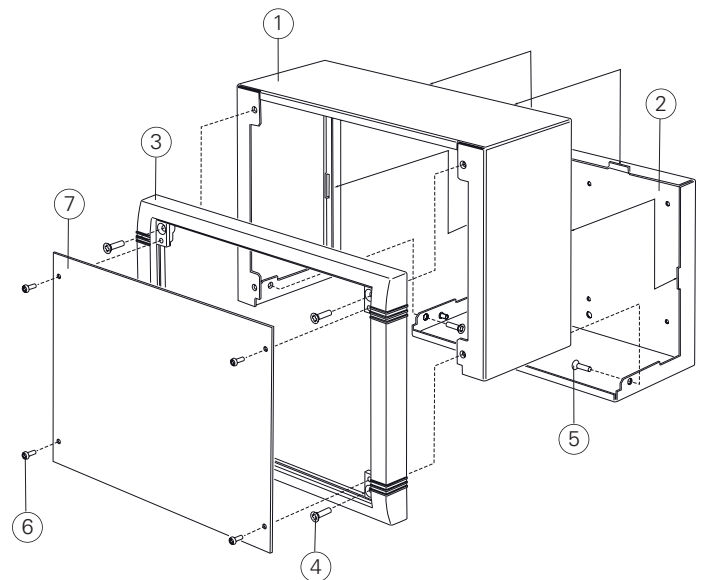

Supply

- ① Top cover
- ② Rear panel
- ③ Front bezel
- ④ M4 x 16 mm (x4)
- ⑤ M4 x 6 mm (x2)
- ⑥ M3 x 6 mm (x4)
- ⑦ *Front panel
- * Accessories

Lieferumfang

- Oberteil
- Rückplatte
- Frontrahmen
- M4 x 16 mm (x4)
- M4 x 6 mm (x2)
- M3 x 6 mm (x4)
- *Frontplatten
- * Zubehör

Fourniture

- Partie supérieure
- Plaque arrière
- Cadre frontal
- M4 x 16 mm (x4)
- M4 x 6 mm (x2)
- M3 x 6 mm (x4)
- *Plaque avant
- * Accessoires



Standard colours
Standardfarben
Coloris standard

Datamet

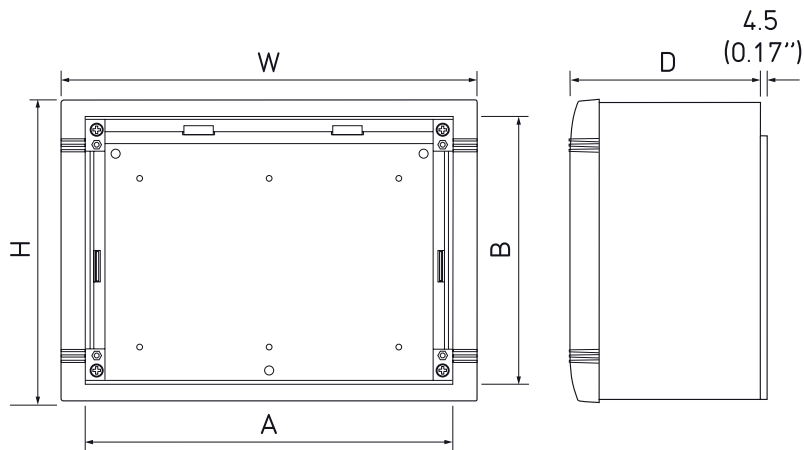

Version S



Version M



Version L

Part No.	Version	Colours	W	H	D	A	B
Bestell-Nr./Réf.		Farben/Coloris					
M 58 25 105	S	● RAL 7035/40	250 (9.84")	180 (7.08")	116 (4.56")	220.7 (8.68")	160.8 (6.33")
M 58 25 109	S	● RAL 9005	250 (9.84")	180 (7.08")	116 (4.56")	220.7 (8.68")	160.8 (6.33")
M 58 35 105	M	● RAL 7035/40	350 (13.78")	250 (9.84")	116 (4.56")	320.7 (12.62")	230.8 (9.08")
M 58 35 109	M	● RAL 9005	350 (13.78")	250 (9.84")	116 (4.56")	320.7 (12.62")	230.8 (9.08")
M 58 40 105	L	● RAL 7035/40	400 (15.74")	300 (11.81")	116 (4.56")	370.7 (14.59")	280.8 (11.05")
M 58 40 109	L	● RAL 9005	400 (15.74")	300 (11.81")	116 (4.56")	370.7 (14.59")	280.8 (11.05")

Front Panel

Frontplatte
Plaque Avant

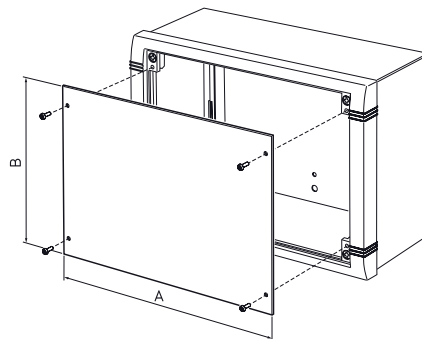

Part No.	Version	A	B
Bestell-Nr./Réf.			
M 58 00 025	S	220 (8.66")	159.5 (6.28")
M 58 00 035	M	320 (12.59")	229.5 (9.03")
M 58 00 040	L	370 (14.56")	279.5 (11.00")



Mounting Plate Kit

Montageplatten-Set
Kit De Plaque Support

Supply: Mounting plate + ①x 6 + ②x 12
Lieferumfang: Montageplatte + ①x 6 + ②x 12
Fourniture: Plaque support + ①x 6 + ②x 12

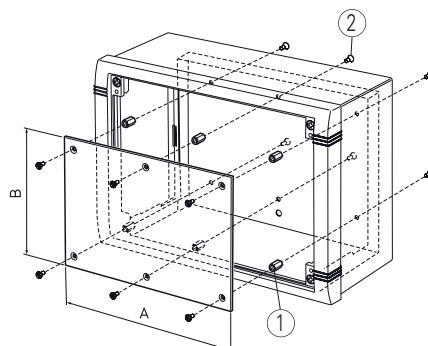

Part No.	Version	A	B
Bestell-Nr./Réf.			
M 58 04 125	S	175 (6.89")	120 (4.72")
M 58 04 135	M	275 (10.82")	190 (7.48")
M 58 04 140	L	325 (12.79")	240 (9.44")

